

KART ENGINE DYNO

KED SERIES

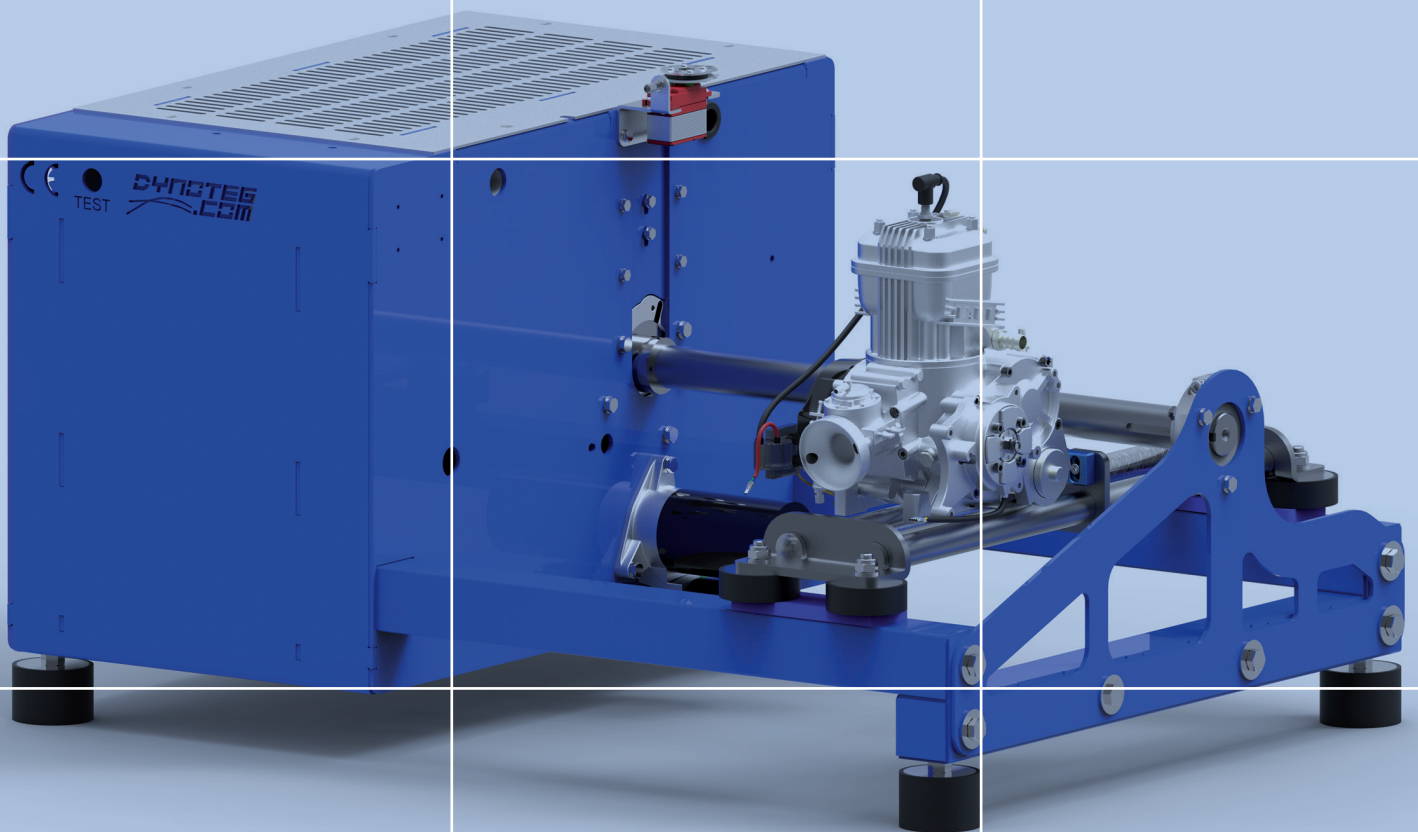

DYNOTEG
.COM

MAKES TUNING EASY

DYNOTEK KED-1 AND KED-2

The KED-1 and KED-2 are our flywheel based Kart Engine Dyno models. An affordable solution with great performance, suitable for acceleration tests and manual engine break in. Both models are standard supplied with a powder coated sub frame. The sub frame is already prepared for a water cooling & pre-heating system so this can always be added later. The dyno's are assembled with high quality parts in order to guarantee durability, smooth operation and outstanding test results.

Measurement principle:

The power and torque are measured by flywheel mass acceleration (inertia) which simulates the weight of the kart and driver. This way of

measuring will generate accurate and reliable results. The engine is mounted in the same way as on the kart (we have a special engine mount for DD2 engines), driven by a chain or by one of our optional tooth belt kits.

One way safety clutch:

The only difference between the KED-1 and the KED-2 is that the KED-2 model is equipped with a high quality one-way safety clutch. This clutch will let the flywheel run free in case the engine suddenly stops. This addition is very useful for engines without a centrifugal clutch, e.g. shifter and direct driven engines.



KED-1 / KED-2 complete with subframe

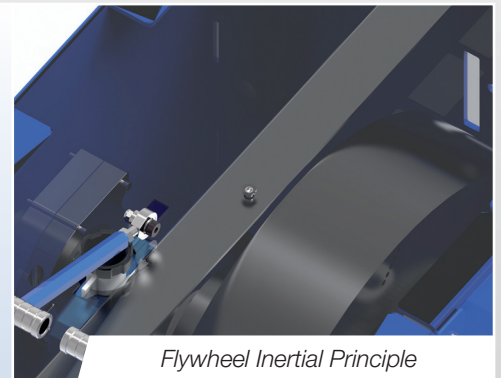

Flywheel Inertial Principle



Hand Levers for Dyno operation

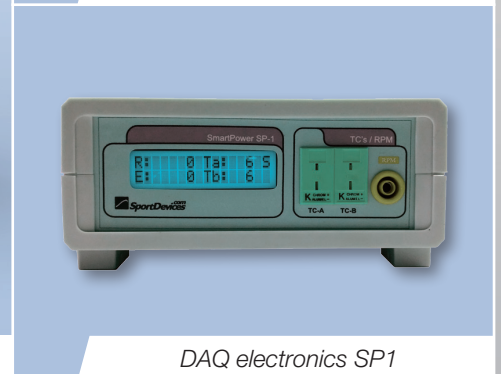

DAQ electronics SP1

DYNOTEG KED-5 EVO

For those who want absolute perfection in engine testing we designed the most advanced and sophisticated Kart Engine Dyno available, KED-5 EVO. The specially designed eddy current brake together with its very fast brake controller makes every kind of high accuracy test possible. The KED-5 EVO design is highly optimized and efficient to perform high accuracy test over a long time. The compact design also guarantees the best possible price for this High Tech dyno.

Operation:

Electronic throttle operation by servo enables fully automated tests as a standard feature. Both throttle and brake can be controlled from the included software and/or with the included foot pedals. It is as easy as

driving an automatic car. For fully automated tests simply select the test program that you want to perform and press START to let the dyno do the work. You want to run in an engine? Simply load the run in test file and press START. Meanwhile you can spend time on other jobs while the dyno is performing automated tests for you.

The automated test files are parametric. This means that you can simply change the main parameters like minimum RPM, maximum RPM, test time, number of cycles etc to match your needs. No programming is required. The special designed eddy current brake even enables track simulation tests. Our optional Dynoteg track data converter software easily converts your (AIM) datalog files to automated test files for the dyno. If your logged



KED-5 EVO complete with subframe

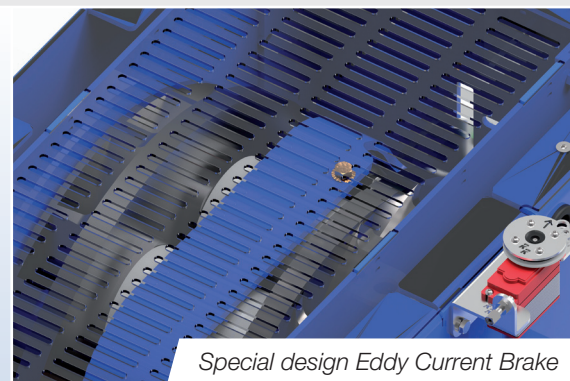

Special design Eddy Current Brake



Foot pedals for Dyno operation

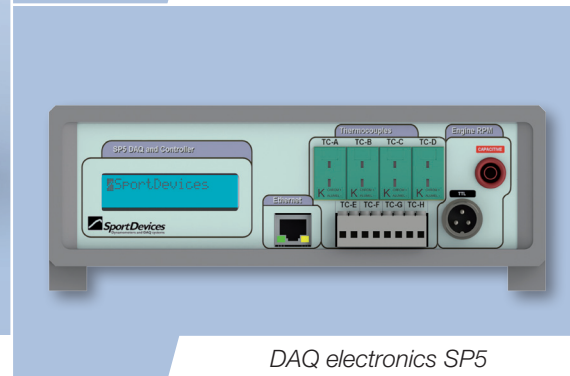

DAQ electronics SP5

A Kart Engine Dyno for every budget!

Nowadays kart racing is very close. Getting the maximum horsepower out of your engine makes the difference between win or lose. Accurate measurement of engine power is very important. Since many years we invest much in constantly improving our Kart Engine Dyno's in order

to guarantee a very high accuracy. Our 3D CAD designs guarantee a high accuracy, high quality, repeatable test results and the best price. The user friendly and intuitive software makes our dyno's easy to use for everybody (no special computer skills required).

OPTIONS AND ACCESSORIES

data contains GPS data then you also see the track layout and the actual position on the track during the simulation.

Manual operation is of course possible as well.

Measurement principle:

The power and torque are measured by recording the torque and RPM of the eddy current brake combined with the inertial power. The installed load cell is calibrated which ensures very accurate and extremely reliable power readings. The eddy current brake enables you to let the engine run at any desired load and rpm.

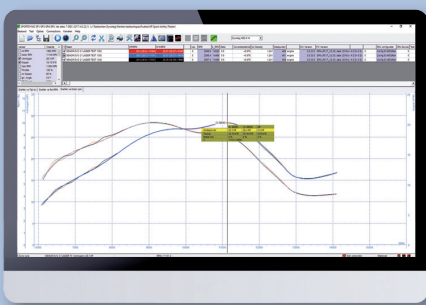

Accurate Power & Torque measurement



Configurable Gauges Window

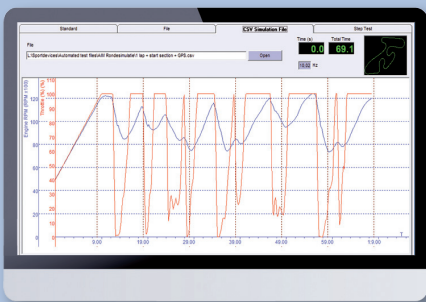

Track Simulation Test

Options and accessories only for the KED-5

Dynoteg CSV file converter software

This software is a one year license which includes free support and updates. The Dynoteg CSV file converter software easily converts your (AIM) datalog files to automated test files for the dyno. If your logged data contains GPS data then you also see the track layout and the actual position on the track during the simulation.

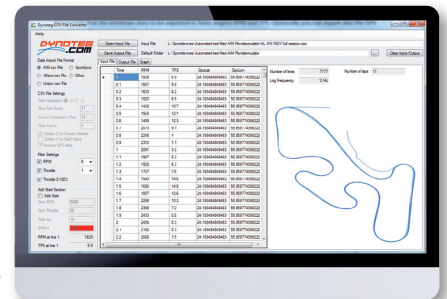

This software can only be used with KED-5 EVO dyno's.

Options and accessories for all KED dyno's

Lambda sensor

The lambda sensor kit measures the mixture and is very helpful to fully understand how the engine responds to carburettor setting changes. It shows exactly how rich or lean the engine runs at different engine speeds and throttle positions.



The set is supplied including a Bosch wide band LSU 4.9 lambda sensor. A connection cable to connect this wide band lambda controller to the KED dyno electronics is optional and available as well.

Temperature sensors

A variety of temperature sensors are available for the Dynoteg KED Series Dyno's. Exhaust gas and water temperature are the most important temperatures to measure to help you to understand the behaviour of the engine performance. For 2-stroke engines we recommend to always measure the exhaust gas temperature.

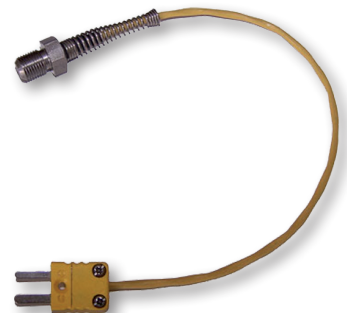

For 4-stroke engines either a water or cylinder head temperature sensor can be very useful.

Please visit our website www.dynoteg.com for more accessories.

Our Kart Engine Dyno's are manufactured in our own workshop to guarantee the best quality. Every dyno is tested before shipment. Feel free to contact us for a free demonstration.

MAKES TUNING EASY

12 V kit

The 12V kit contains a 12V battery, battery charger and connection block for external connection of ignition, external starter, lambda etc. The 12V kit is also needed for the water cooling system.

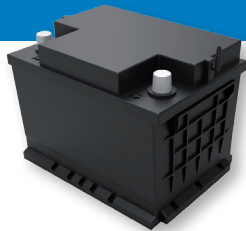

Water pre-heating & cooling system

This system pre-heats the engine to the desired temperature and maintains the set temperature during the test runs. So you can immediately start testing the engine after the pre-heating process. The constant water temperature improves measurement accuracy and repeatability as well.



Electrical starter kit

The electrical starter kit is necessary for engines which are not equipped with a starter (for example KZ and OK engines). The electrical starter kit can only be purchased together with the water cooling system and the 12V kit.



Weather station

The weather station automatically inserts the correct temperature, barometric pressure and humidity in each test. This information is needed by the software to calculate the correct engine power based on the weather conditions.



Special engine mount kits

Besides the standard 28, 30 and 32 mm engine mounts we also have special engine mounts for DD2 and RK1 engines.



Fuel tank support

This fuel tank support lets you easily mount a standard kart fuel tank on your KED dyno.



Tooth belt kits

Available for Rotax, Iame X30 and Vortex ROK. This improves measuring accuracy as the friction is always the same. Chains give lower power measurements when they start wearing. A tooth belt kit also produces less noise, no dirt from chain grease and it will save a lot of money on chains and sprockets.



Rotax chain/tooth belt protection cover

The Rotax Max chain/tooth belt protection kit ensures that you can test safely with the tooth belt kit for Rotax Max kart engines on Dynoteg KED Kart Engine Dyno's. The cover replaces the original Rotax cover as the original cover is too small to be used with the tooth belt kit. The kit can also be used with chains.



Fan

The multi-purpose fan can be used for example for drive wind, cooling air and/or test room ventilation. The fan capacity is 3.250 m3/h. The input power is 1255 Watt – 230 VAC. This fan can also be used in combination with our fan controller.



Fan controller

This controller enables you to control the fan speed linear with the Dyno speed or manually with a potentiometer.

The fan controller is suitable for 230 VAC fans with a maximum current of 10 A.



Exhaust gas extraction fan set

For safe and healthy testing we also recommend our exhaust gas extraction fan set.

The set contains an explosion proof fan (demanded by insurance company), wall mount, flexible hose, adapters and power switch. On request a high temperature resistant flexible hose is available.



Exhaust gas extraction KED mounting kit

This mounting kit is specially designed for the KED series and enables you to easily connect the exhaust gas extraction hose to the exhaust of any kart engine. This kit can be used together with the exhaust gas extraction fan set.



Please visit our website www.dynoteg.com for more accessories.

How to make money with your dyno?

Purchasing a dyno is good way to earn money. It raises the level of your business and you can invoice test jobs to your customers. Testing generally costs € 75 to € 100 per hour. A simple calculation shows how fast you can earn back your investment. Reality shows us that most customers

earn back their investment within 1 year.

Example:

Investment: € 10.000

Earned back after: $10.000/75 = 133$ hours of testing.

TECHNICAL SPECIFICATIONS

	KED-1	KED-2	KED-5 EVO
Measurement Principle	<i>Flywheel mass</i>	<i>Flywheel mass</i>	<i>Eddy current brake</i>
One-way safety clutch	✘	✔	✘
Data acquisition system	<i>SP1</i>	<i>SP1</i>	<i>SP5</i>
Thermocouple temperature inputs	2	2	8
Analog 0 - 5 Volt inputs	4	4	6
Throttle servo output signal	✘	✘	✔
Fan controller output signal	✘	✘	✔
RS232 PC connection	✔	✔	✔
Ethernet PC connection	✘	✘	✔
Relay outputs	✘	✘	8
Engine support	<i>28, 30 or 32 mm</i>	<i>28, 30 or 32 mm</i>	<i>28, 30 or 32 mm</i>
Maximum power	<i>55 Hp / 40 kW</i>	<i>55 Hp / 40 kW</i>	<i>55 Hp / 40 kW</i>
Acceleration test	<i>Inertial</i>	<i>Inertial</i>	<i>Eddy current brake (inertial up to 10HP)</i>
Manual engine break in	✔	✔	✔
Automated engine break in test	✘	✘	✔
Static test (steady mode)	✘	✘	✔
Automated step test	✘	✘	✔
Automated track simulation test (<i>CSV file import</i>)	✘	✘	✔
Automated customized test (<i>sequencer commands</i>)	✘	✘	✔
Remote throttle control including foot pedal	○	○	✔
12V kit (<i>battery + charger + 12V connections for ignition, external starter and lambda</i>)	○	○	✔
Electrical starter kit (<i>only in combination with 12V kit</i>)	○	○	○
Sub frame (<i>height = 50 cm</i>)	✔	✔	✔
Power supply	<i>230 VAC - 1 A</i>	<i>230 VAC - 1 A</i>	<i>230 VAC - 9 A</i>
Power supply including water cooling system	<i>230 VAC - 10 A</i>	<i>230 VAC - 10 A</i>	<i>230 VAC - 18 A</i>

- ✔ *Standard*
- *Optional*
- ✘ *Not possible / available*



Roteg Racing BV
 Kleiland 9E
 8271 RV IJsselmuiden
 The Netherlands

☎ +31 (0)38 423 85 82
 ✉ info@roteg.nl
 🌐 www.roteg.nl
 🌐 www.dynoteg.com

MAKES TUNING EASY